



**Model No. LED-880P-ALA6M**  
**880nm INFRARED FIBER COUPLED LED SYSTEM**

The LED-series 880nm infrared fiber coupled LED system is constructed with features of stable output intensity, long lifetime and high power. It is widely used in spectroscopy, optogenetics, fluorescence excitation and many other applications.

**SPECIFICATIONS**

<b>Model No.</b>	<b>LED-880P-ALA6M</b>	
<b>Nominal wavelength (nm)</b>	880	
<b>Color</b>	Infrared	
<b>Bandwidth FWHM (nm)</b>	50	
<b>Fiber connector</b>	SMA905	
<b>Numerical aperture (NA)</b>	0.22	
<b>Typical <math>\phi 600\mu\text{m}</math> core fiber output power SMA (mW)</b>	1.0	
<b>Maximum current CW (mA)</b>	1000	
<b>Forward voltage (V)</b>	1.7	
<b>Output power stability</b>	<5%	
<b>LED head</b>	64 (L) x46.5 (W) x30 (H) mm <sup>3</sup>	
<b>Power supply</b>	Input voltage	5V DC
	Dimensions	114 (L) x78 (W) x71 (H) mm <sup>3</sup>
<b>Operating mode</b>	CW ( <b>M=C</b> ); CW with TTL modulation: 1Hz-1kHz ( <b>M=T1</b> ), 1kHz-10kHz ( <b>M=T2</b> ); CW with Analog modulation: 1Hz-1kHz ( <b>M=A1</b> ), 1kHz-10kHz ( <b>M=A2</b> )	
<b>Operating temperature (°C)</b>	10 to 35 °C	
<b>Typical lifetime (h)</b>	~10,000	

**Note: The above specifications are subject to change without notice.**

**MECHANICAL OUTLINE (unit: mm)**

**LED Head**

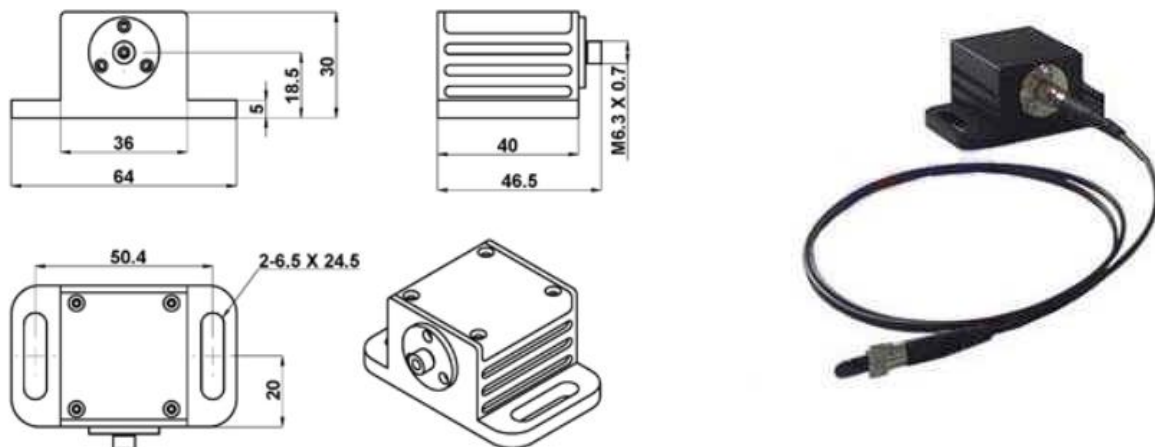



Power Supply

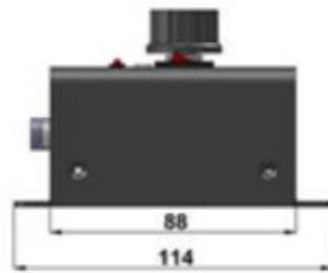
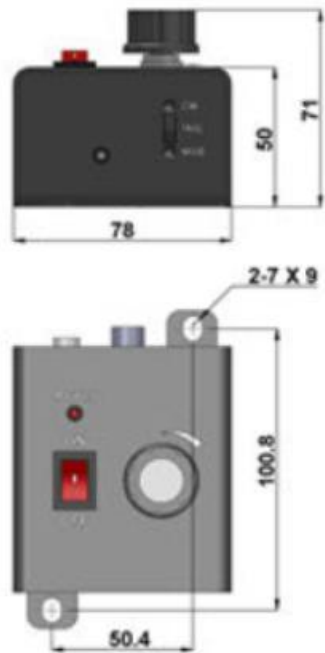

Note: The above specifications are subject to change without notice.