



Model No. IMLN-975-XFYP2Q
975nm INFRARED DIODE LASER SYSTEM UP TO >10W

The IMLN-series 975 nm infrared diode laser is constructed with features of high stability, FDA compliance, high power, ultra-compactness, long lifetime, cost-effectiveness and easy operation. It is widely used in measurement, communication, spectrum analysis, and many other applications. *In addition, fiber coupled IMLN-series 975nm diode lasers with FC or SMA905 connector are available upon request.*

SPECIFICATIONS

Model No.	IMLN-975-XFYP2Q
Wavelength (nm)	975±5
Output power (mW)	>8000 (X=8W), >10000 (X=10W)
Transverse mode	Multimode
Operating mode	CW
Power stability (rms, over 4 hours)	<1% (P=D)
M² factor	<20
Beam diameter at aperture (1/e²,mm)	5~8
Beam divergence, full angle (mrad)	<3.0
Warm-up time (minutes)	<5
Beam height from base plate (mm)	68.5
Operating temperature (°C)	10~35
Laser head	245(L) x99(W) x94(H) mm ³ , 2.5 kg
Power supply (100-240VAC)	High Power Elite Power Supply (Y=H): 275(L) x145(W) x104(H) mm ³ , 2.1kg; complete FDA compliant features (turnkey switch and interlock); easy to operate; CW mode with optional TTL or Analog modulation up to 30kHz High Power Laboratory Power Supply (Y=M): 277(L) x145(W) x106(H) mm ³ , 2.3kg; complete FDA compliant features (turnkey switch and interlock) with more functions; CW mode with adjustable output power knob, operating current LED display, and optional TTL or Analog modulation up to 30kHz
Optional modulation	None (Q=0) TTL: 1Hz -1kHz (Q=1), 1kHz -10kHz (Q=2), 10kHz-30kHz (Q=5) Analog: 1Hz -1kHz (Q=3), 1kHz -10kHz (Q=4), 10kHz-30kHz (Q=6)
Expected lifetime (hours)	10,000
Warranty	10 months
Remarks	The stability of output power may change when you adjust the output power. For example, the stability of output power at the maximum output power is <10%, the stability may change to >10% when you adjust the output power down.

Note: The above specifications are subject to change without notice.





MECHANICAL OUTLINE (unit: mm)

Laser Head

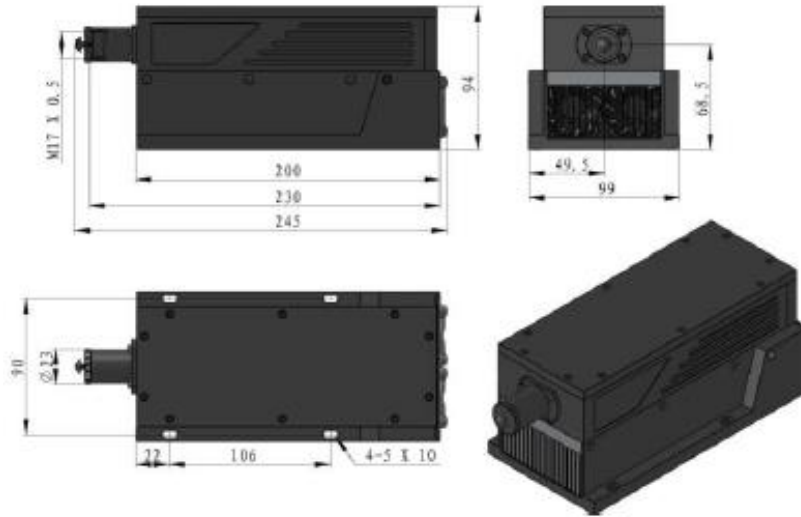

Power Supply

High Power Elite Power Supply (Y=H)

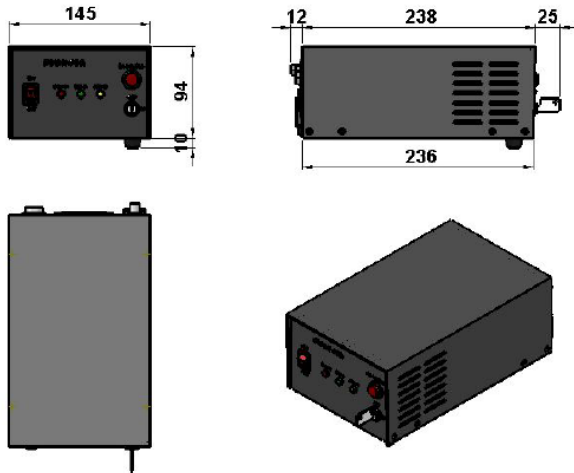

High Power Laboratory Power Supply (Y=M)

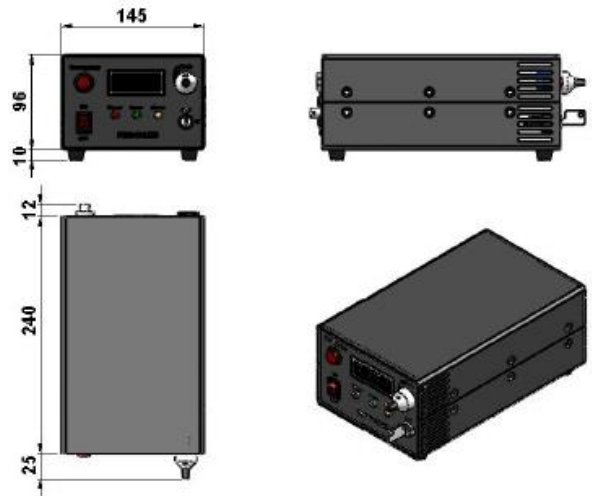

Note: The above specifications are subject to change without notice.